

LED CANOPY LIGHT



Application: Parking structures, storage areas, shopping area walkways, entryway, low roof security and much more

Feature:

- Fins design, advective grooves between fins are good for heat dissipation
- Die-cast aluminum housing with die-cast backbox with four conduit entry points and knockout pattern for junction box or direct wall mounting. Hinged door for easy re-assembly
- Ingress Protection rating of IP65 for dust and water
- High-temperature silicone gaskets
- Wide beam angle to 155° and lighting transmission rate of lens is over 90%

Certifications

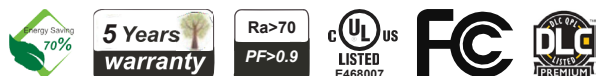

SPECIFICATIONS:

SKU	HYA-GC-40W-P-5000K	HYA-GC-70W/60W/40W-CCT
Model No.	TS-GCP1040-40W-G-50K	TS-GCP1070-70W-G-H-TCP
Wattage	40W	70W/60W/40W Adjustable
CCT	5000K	3000/4000/5000K Selectable
Mounting Height	8' to 15'	
Lamp Bead Model	Samsung	
Lighting Angle	155°	
Lighting Efficiency	130 Lm/W	
Color Rendering Index	Ra>70	
Working Temperature	-40 °F ~ +104 °F / -40 °C ~ +40 °C	
Storage Temperature	-40 °F ~ +158 °F / -40 °C ~ +70 °C	
Environment Location	IP 65 - Wet Location	
Lifespan	≥ 50000H	
Lampshell	DARK BROWN	
DLC ID	P8MGTOX9	S-C9FQUD
Package Info	10.39"x4.4"x10.5" 264x112x266 mm	11.89"x5.52"x11.62" 302x140x295 mm
PC/Master Pack	6	4
Master Package Info	21.46"x18.43"x11.4" 545x4687x290 mm	23.04"x12.48"x12.41" 585x317x315 mm
Master Package Weight	26.34 LB	28.35 LB

DIMENSIONS

40W

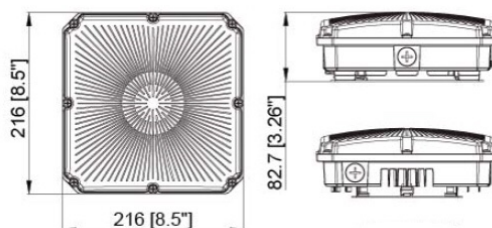

70W

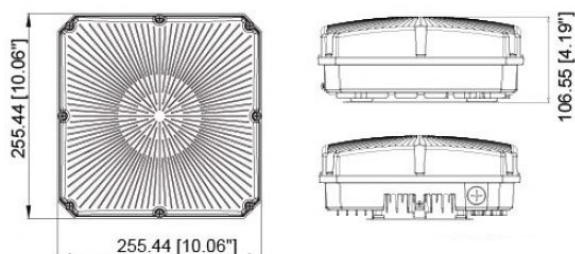

ORDERING CODE DEFINITION

EXAMPLE: HYA-GC-70W-P-5000K

Company Code	Product	Power	DLC	CCT
HYA	GC: Garage Canopy Light	40W	P: DLC Premium Listed	5000K
		70W/60W/40W		3000/4000/5000K Selectable

LED CANOPY LIGHT

Installation

CCT & WATTAGE SELECTABLE INSTRUCTION

1. Use a large screwdriver to screw out the rubber plug in the middle.

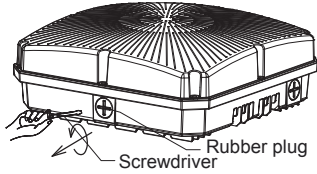

2. Finger through the thread hole to dial the CCT and Wattage Switch to the specified color temperature and Wattage.

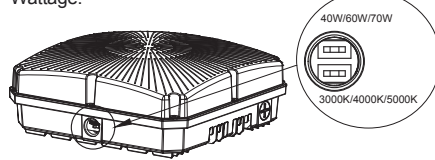

3. Use a large screwdriver to tighten the rubber stopper in the middle.

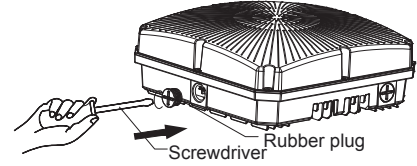

Installation method I : Ceiling Installation

1. Loosen the screw to take off the mounting plate from the lamp.

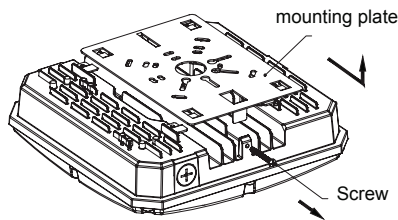

2. Use screws to lock the mounting plate on the embedded junction box.

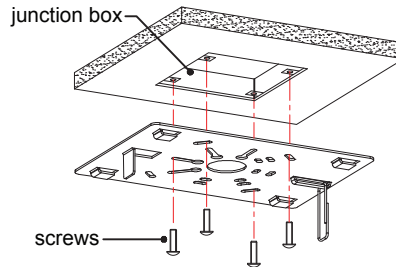

3. Hang the lamp on the ring so as to connect wires with terminal caps.

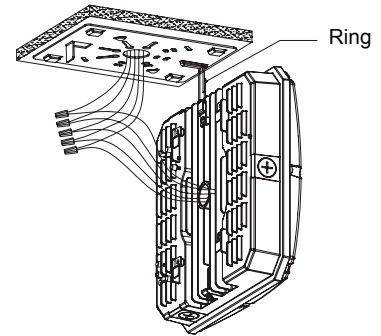

4. Hook up lamp on the mounting plate.

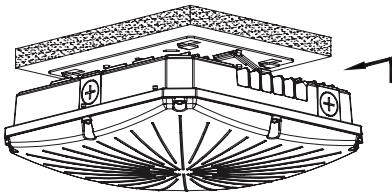

5. Secure the screw. Installation complete

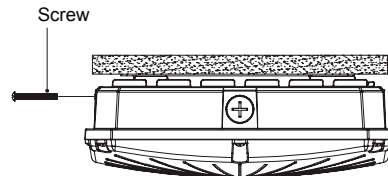

Input/Dimmer Lamp

Green	○	Green
White	○	White
Black	○	Black
Dim-	○	Pink
Dim+	○	Purple

*this connection can be omitted if with non-dim driver
0-10V Dimming*

Installation method II: Pole-pendent Installation

1. Connecting wires with terminal caps picture shows

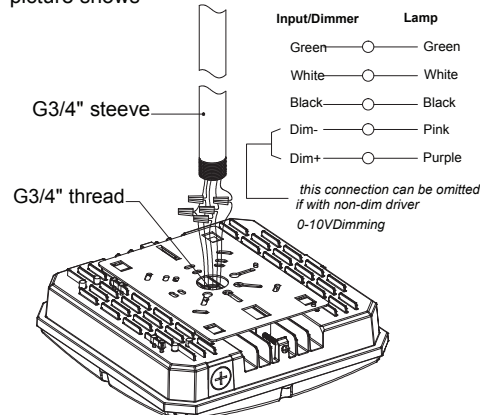

2. Rotating the steeve to make it fixed with lam Installation completed.

